

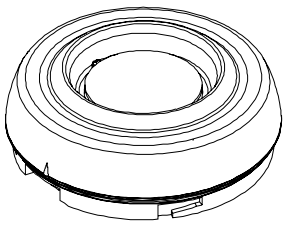











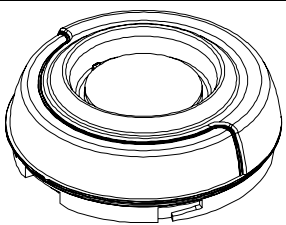

FDS224-x	FDS225-x	FDS226-xx	FDS227-xx-C
----------	----------	-----------	-------------

	FDS224-x	
	FDS225-x	 +  + 
	FDS226-xx	 
	FDS227-xx	 +  +  
	FDS227-xx-C	 +  +  



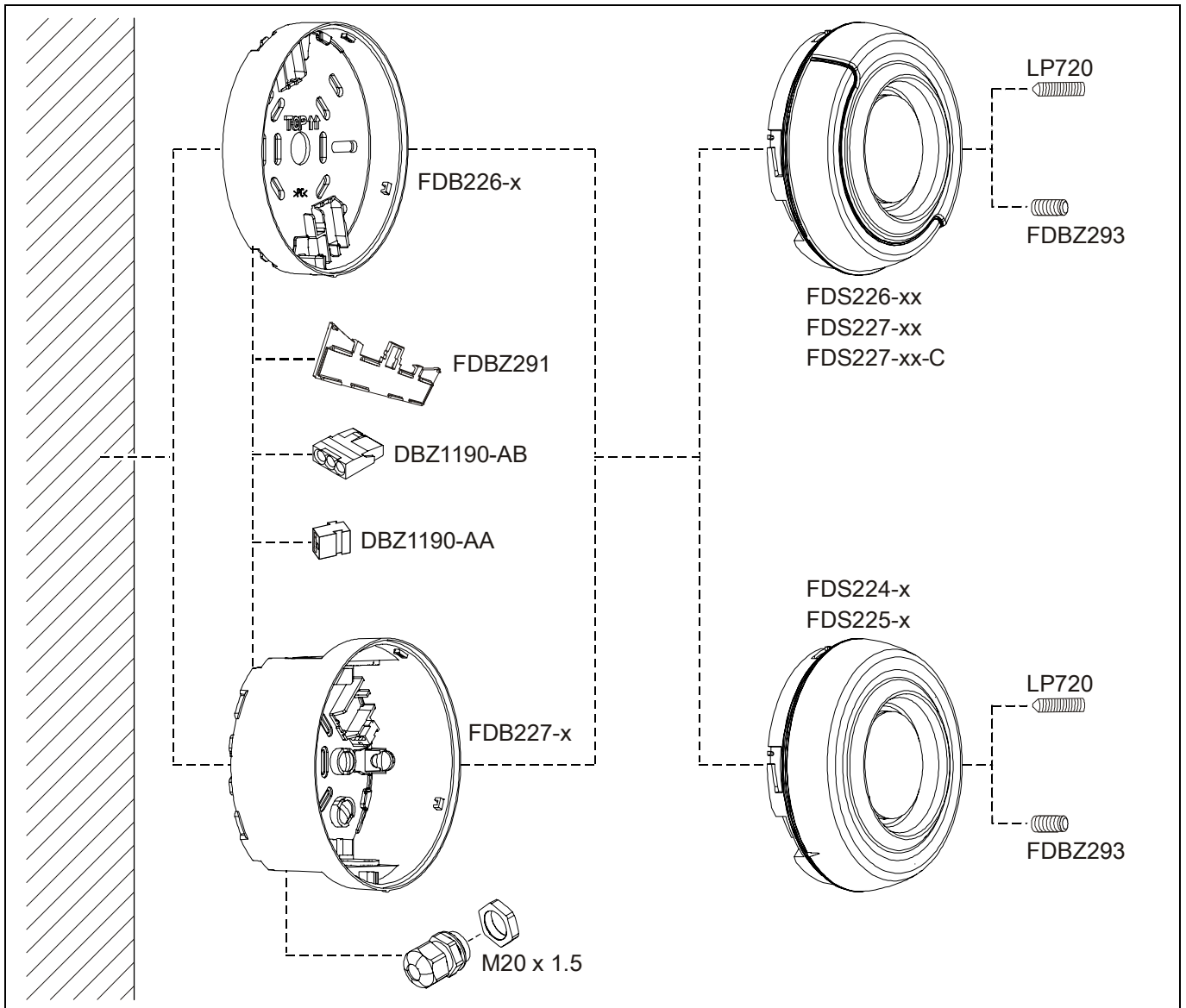

-25...+70 °C



≤95 % rel.

1

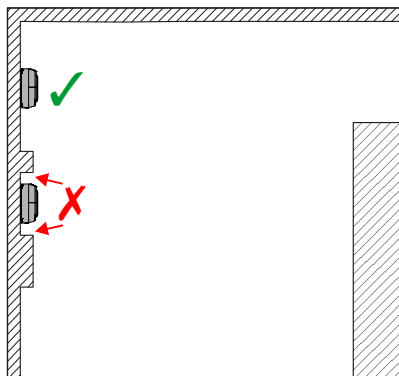
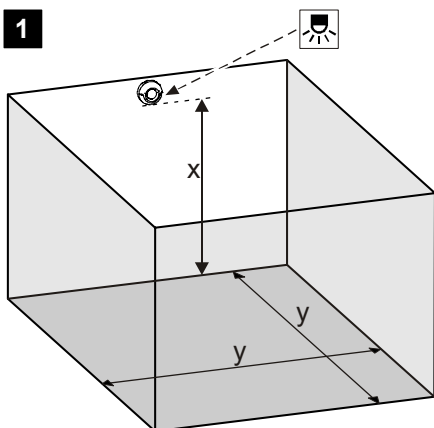

		Max.		
		x	y	
FDS226-xW	W-3.2-10	3.2	10	High
	W-2.4-7.5	2.4	7.5	Medium
FDS227-xW	O-2-6.2	2	6.2	Low
FDS226-xR	W-2.8-8.8	2.8	8.8	High
	W-2.4-7.5	2.4	7.5	Medium
FDS227-xR	O-2-6.2	2	6.2	Low

2

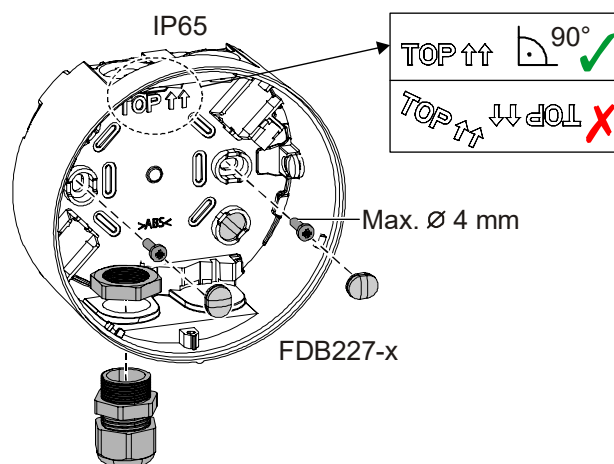
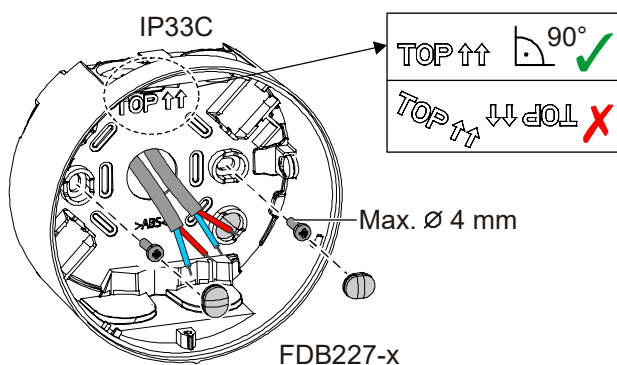
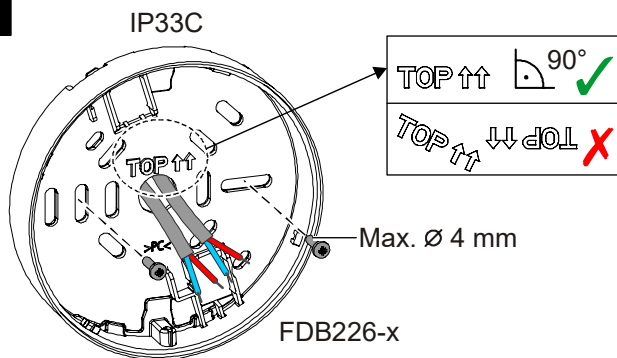

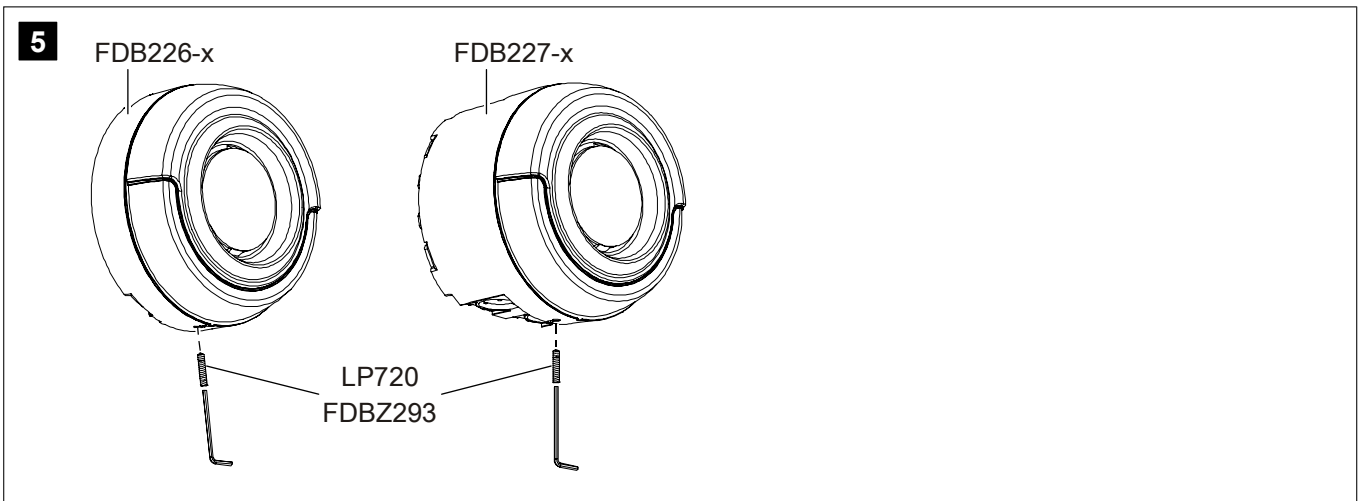
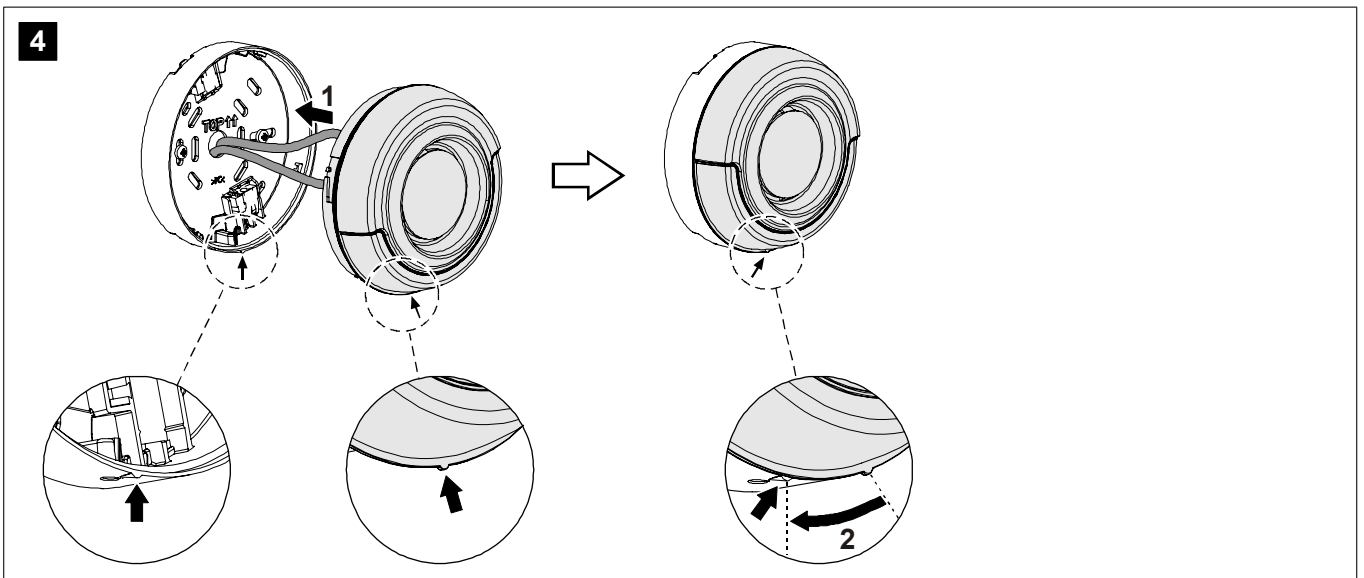
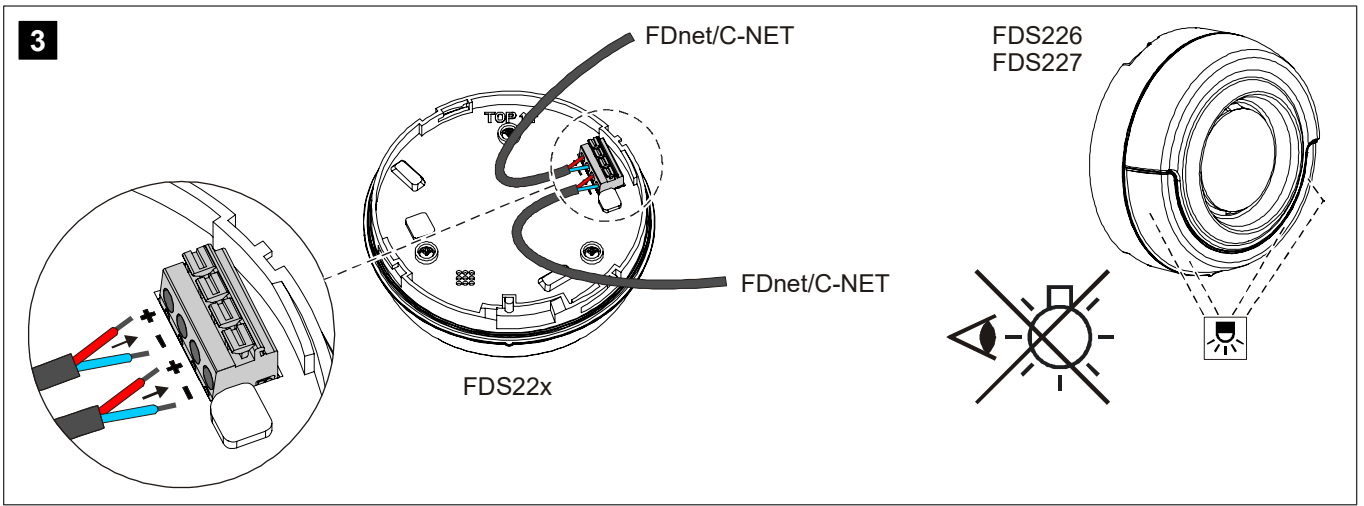



			<a href="https://siemens.com/bt/download">https://siemens.com/bt/download</a>
			<p>➔ A6V10725350</p>

18  2831	<b>FDS224</b>	Siemens Schweiz AG; Theilerstrasse 1a CH-6300 Zug Technical data: see doc. <b>A6V10725350</b>
FDS224 - Sounder incl. Short-circuit isolator		
305/2011/EU (CPR): EN 54-3 / EN 54-17 ; 2014/30/EU (EMC): EN 50130-4 / EN 61000-6-3 ; 2011/65/EU (RoHS): EN 50581		
The declared performance and conformity can be seen in the Declaration of Performance (DoP) and the EU Declaration of Conformity (DoC), which is obtainable via the Customer Support Center: Tel. +49 89 9221-8000 or <a href="https://siemens.com/bt/download">https://siemens.com/bt/download</a>		
DoP No.: DOP190211 ; DoC No.: CED-FDS224		

18  2831	<b>FDS225</b>	Siemens Schweiz AG; Theilerstrasse 1a CH-6300 Zug Technical data: see doc. <b>A6V10725350</b>
FDS225 - Sounder incl. Short-circuit isolator		
305/2011/EU (CPR): EN 54-3 / EN 54-17 ; 2014/30/EU (EMC): EN 50130-4 / EN 61000-6-3 ; 2011/65/EU (RoHS): EN 50581		
The declared performance and conformity can be seen in the Declaration of Performance (DoP) and the EU Declaration of Conformity (DoC), which is obtainable via the Customer Support Center: Tel. +49 89 9221-8000 or <a href="https://siemens.com/bt/download">https://siemens.com/bt/download</a>		
DoP No.: DOP190212 ; DoC No.: CED-FDS225		

18  2831	<b>FDS226</b>	Siemens Schweiz AG; Theilerstrasse 1a CH-6300 Zug Technical data: see doc. <b>A6V10725350</b>
FDS226 - Visual alarm device/sounder incl. Short-circuit isolator		
305/2011/EU (CPR): EN 54-3 / EN 54-17 / EN 54-23 ; 2014/30/EU (EMC): EN 50130-4 / EN 61000-6-3 ; 2011/65/EU (RoHS): EN 50581		
The declared performance and conformity can be seen in the Declaration of Performance (DoP) and the EU Declaration of Conformity (DoC), which is obtainable via the Customer Support Center: Tel. +49 89 9221-8000 or <a href="https://siemens.com/bt/download">https://siemens.com/bt/download</a>		
DoP No.: DOP190213 ; DoC No.: CED-FDS226		

18  2831	<b>FDS227</b>	Siemens Schweiz AG; Theilerstrasse 1a CH-6300 Zug Technical data: see doc. <b>A6V10725350</b>
FDS227 - Visual alarm device/sounder incl. Short-circuit isolator		
305/2011/EU (CPR): EN 54-3 / EN 54-17 / EN 54-23 ; 2014/30/EU (EMC): EN 50130-4 / EN 61000-6-3 ; 2011/65/EU (RoHS): EN 50581		
The declared performance and conformity can be seen in the Declaration of Performance (DoP) and the EU Declaration of Conformity (DoC), which is obtainable via the Customer Support Center: Tel. +49 89 9221-8000 or <a href="https://siemens.com/bt/download">https://siemens.com/bt/download</a>		
DoP No.: DOP190214 ; DoC No.: CED-FDS227		